

# Instruction Manual

## Waterproof Case

# PFL-01

For the electronic flash  
FL-20

- Thank you for buying the Underwater Case PFL-01.
- Please read this instruction manual carefully and use the product safely and correctly.
- Please keep this instruction manual for reference after reading it.
- Wrong use may cause damage to the flash on the inside from water leakage, and repair may not be possible.
- Before use, perform an advance check as described in this manual.

**OLYMPUS CORPORATION**

## Disclaimer

- Unauthorised copying of this manual in part or in full, except for private use, is prohibited. Unauthorised reproduction is strictly prohibited.
- OLYMPUS CORPORATION shall not be responsible in any way for lost profits or any claims by third parties in case of any damage occurring from incorrect use of this product.
- OLYMPUS CORPORATION shall not be responsible in any way for damage, lost profits, etc. caused by the loss of image data due to defects, disassembly, repair or modification of this product by people, other than third parties specifically authorised by OLYMPUS CORPORATION or for other reasons.

## Please read the following before using the product

- This product has been precision-crafted from high quality polycarbonate. When used correctly, it lets you take photographs safely up to a water pressure equivalent to a depth of 40 metres.
- To ensure correct and safe use of the case, please read all instructions on handling and carrying out the system check as well as care, maintenance and storage of the case.
- OLYMPUS CORPORATION shall in no way be responsible for damage caused by water to the flash contained in the case.
- OLYMPUS CORPORATION shall not pay any compensation for accidents (injuries or material damage) that may occur during the use of this product.
- The electronic flash cannot be used in AUTO mode when it is inserted in this case.
- A commercially available bracket arm is required to use this product in combination with the PT-020.

## For safe use

This instruction manual uses various pictographs for correct use of the product and to prevent danger to the user and other persons as well as property damage. These pictographs and their meanings are shown below.

**⚠ WARNING** This indicates contents for which the possibility of human death or severe injury in case of handling under disregard of this indication can be assumed.

**⚠ CAUTION** This indicates contents for which the possibility of human injury or the possibility of material damage in case of handling under disregard of this indication can be assumed.

## ⚠ WARNING

1. Keep this product out of the reach of babies, infants, and children. There is the possibility of occurrence of the following types of accidents.
  - Injury by dropping onto the body from a height.
  - Injury from parts of the body getting caught in parts which open and close.
  - Swallowing of small parts. Please consult a physician immediately if any parts have been swallowed.
  - Triggering of the flash in front of the eyes may cause permanent vision impairment etc.
2. Never store this product with an electronic flash with batteries inside. Battery leakage could result in a fire or an explosion.
3. If water comes into contact with the electronic flash inside this product, remove the batteries from the flash immediately. Otherwise, hydrogen gas could be produced, which could lead to a fire or an explosion.
4. This product is made of resin. There is the possibility that injuries may be caused when it becomes broken because of strong impact with a rock or other hard objects. Please handle with sufficient care.
5. The silica gel and the grease for silicone O-rings for this product are not edible.

## ⚠ CAUTION

1. Do not disassemble or modify this product. This may cause water leakage or trouble. In case of disassembly or modification by persons other than those appointed by OLYMPUS CORPORATION, the guarantee shall not apply.
2. Do not place this product at locations with abnormally high or abnormally low temperatures or at locations with extreme temperature changes. The product may deteriorate.
3. Opening and closing at locations with much sand, dust, or dirt may impair the waterproof characteristic and cause water leakage. This should be avoided.
4. This product is suitable for use at water pressures equivalent to depths of up to 40 meters. Please note that diving at depths greater than 40 meters may result in deformation or damage to this product, as well as to the camera and lens. In this case, water penetration may occur.

5. Rough handling, such as jumping into the water with the case in your hand or in an outside pocket or throwing the case into the water could lead to water penetration. Please always take care when using the case.
6. If the electronic flash contained in the case gets wet, wipe off all moisture immediately and check the flash is working correctly.
7. Before traveling by air, please make sure you remove the O-rings, otherwise the difference in air pressure may make it impossible to open the case.
8. To ensure safe and trouble-free handling and operation of the electronic flash in this product, please read the flash's instruction manual carefully.
9. When sealing this product, please take care to ensure no foreign matter such as sand, dirt or hair is on the O-rings or contact surfaces.
10. Before storing this product, always be sure to take out the flash.
11. When using this product, do not fire the flash at close range to a person or animal.

## Batteries

- To supply power to the electronic flash, we recommend you use two LR6 alkaline batteries, two lithium batteries, two Ni-Mn batteries, two Ni-Mh batteries or two Ni-Cd batteries.
- Keep the batteries' contacts away from damp and humidity to avoid impairing performance and/or causing an accident.
- For other battery handling precautions, please read the relevant sections in the electronic flash's instruction manual.

## For Prevention of Water Leakage Accidents

If water gets inside this product during use, irreparable damage may be caused to the electronic flash inside the case. Please note the following points.

1. When sealing this product, make sure that no hairs, fibers, sand particles or other foreign matter stick not only to the O-ring, but also to the contact surface. Even a single hair or a single grain of sand may cause water leakage. Please check with special care.
2. The O-ring is a consumption product. Please replace it at least

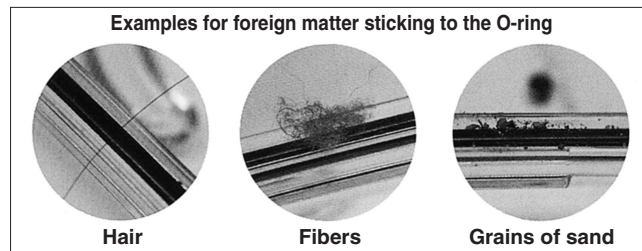

- once a year by new one. Also perform maintenance for every use.
3. Deterioration of the O-ring will progress according to the use conditions and the storage conditions. Immediately replace the O-ring by a new one if it is damaged, shows cracks, or has lost its elasticity.
4. At the time of O-ring maintenance, clean the inside of the O-ring groove and confirm the absence of dirt, dust, sand, and other foreign matter.
5. Apply the specified silicone O-ring grease to the O-ring.
6. The waterproof function is not effective when the O-ring is not installed correctly. When installing the O-ring, take care that it does not project from the groove and that it is not twisted. Also, when sealing the Case, close the lid after confirming that the O-ring has not come out of the groove.
7. This product is an airtight construction made of plastic (polycarbonate). When it is left for a long time in a car, on a boat, at the beach, or at other places reaching a high temperature, or when it is subjected for a long time to uneven external force, it may be deformed and the waterproof function may be lost. Pay sufficient attention to temperature control. Also do not place heavy objects onto the product during storage or transport, and avoid unreasonable storage.
8. When the O-ring contact surface is pressed strongly from the

outside of the Case, or when the Case is twisted, the waterproof function may be lost. Take care not to exert excessive force.

9. Please be sure to perform the advance test and the final test each time before using the case.
10. If you see any drops of water or any other signs of water penetration during use, stop the dive immediately. Carefully dry from the flash and waterproof case, and then perform the "Final System Check" and confirm whether any water actually penetrated this product.

## Handling the Product

- Use or storage of the product at the following locations may cause defective operation, defects, trouble, damage, fire, internal clouthing, or water leakage. Always avoid these locations.
  - Places where high temperatures exist, such as in direct sunlight, in a closed vehicle, etc., and/or where extreme differences in temperatures exist.
  - Places where there is a lot of dust.
  - Places where there are open fires.
  - Places subject to vibrations.
  - Places where volatile chemicals are stored or used.
  - water deeper than 40 meters.
- This product is made of polycarbonate resin with excellent impact resistance, but it may be damaged by scraping against rocks etc. It also may break when it hits hard objects or is dropped.
- This product is not intended as a case to protect the internal flash from heavy knocks. If the case is subjected to a heavy knock or significant pressure, the flash inside may be severely damaged.
- When this product is not used for a long time, the O-rings may deteriorate, diminishing its waterproof properties. Therefore, please use the case only after first performing the first and final system checks described in this instruction manual.
- Do not apply excessive force to the arm mount and underwater TTL cable connector.
- The range of the flash underwater may be lower than on land depending on the conditions at the time of shooting (clarity of the water, suspended matter, etc.). Be sure to check the image before actual shooting.
- Do not use the following chemicals for cleaning, corrosion prevention, prevention of fogging, repair or other purposes. When these are used for the Case directly or indirectly (with the chemicals in vaporized state), they may cause cracking under high pressure or other problems.

Chemicals which cannot be used	Explanation
Volatile organic solvents, chemical detergents	Do not clean the Case with alcohol, gasoline, thinner or other volatile organic solvents or with chemical detergents etc. Pure water or lukewarm water is sufficient.
Anticorrosion agent	Do not use anticorrosion agents. The metal parts use stainless steel or brass, and washing with pure water is sufficient.
Commercial defogging agents	Do not use commercial defogging agents. Always use the specified desiccant silica gel.
Grease other than specified silicone grease	Use only the specified silicone grease for the silicone O-ring, as otherwise the O-ring surface may deteriorate and water leakage may be caused.
Adhesive	Do not use adhesive for repairs or other purposes. When repair is required, please contact a dealer or a service station of our company.

- Do not perform operations other than specified in this instruction manual, do not remove or modify parts other than specified, and do not use parts other than specified. Any troubles in taking pictures or with the equipment resulting from the above actions shall be outside the guarantee.
- OLYMPUS CORPORATION does not assume any liability for damage to the flash caused by water penetration.
- OLYMPUS CORPORATION shall not pay any compensation for accidents (injury or material damage) at the time of use.

## Contents

Disclaimer	E-1
Please read the following before using the product	E-1
For safe use	E-1
Batteries	E-3
For Prevention of Water Leakage Accidents	E-4
Handling the Product	E-5

## Contents E-7-8

### 1. Preparations E-9

Checking the contents of the package	E-9
Names of the parts	E-10
Preparing the case	E-11
Attaching/removing/the diffuser plate	E-11
Connection to the camera case	E-12
1) Connecting the underwater TTL cable	E-12
2) Connecting the hot shoe cable	E-13
3) Mounting on an arm	E-14

### 2. Advance Check of the Case E-15

Advance test before use	E-15
Advance Test	E-15

### 3. Insertion of the electronic flash E-16

Checking the electronic flash	E-16
Checking the Batteries	E-16
Inserting in the case	E-16
Which electronic flashes can be used?	E-16
Opening the case	E-17
Inserting the flash	E-17
Insertion of silica gel	E-18
Check the loading status	E-19
Seal the Case	E-19
Perform the final check	E-20
Visual inspection	E-20
Setting the flash power to ON and OFF	E-20
Final Test	E-21

### 4. Taking photos underwater E-22

Setting the flash mode	E-22
Underwater TTL AUTO shooting	E-22
Underwater MANUAL shooting	E-22

### 5. Handling after use E-23

Wipe off any waterdrop	E-23
Removing the electronic flash	E-24
Cleaning the case with pure water	E-24
Disconnecting the TTL cable	E-25
Drying the case and TTL cable	E-25

### 6. Maintaining the Waterproof Function E-26

Remove the O-ring.	E-26
Remove any sand, dirt, etc.	E-26
Install the O-ring.	E-27
How to Apply Grease to the O-ring	E-27
Replace consumable products.	E-28

### 7. Appendix E-29

Q & A on the use of the PFL-01	E-29
After-sale Service	E-34
Specifications	E-35

## 1. Preparations

### Check the contents of the package.

Check that all accessories are in the box.  
Contact your dealer if accessories should be missing or damaged.

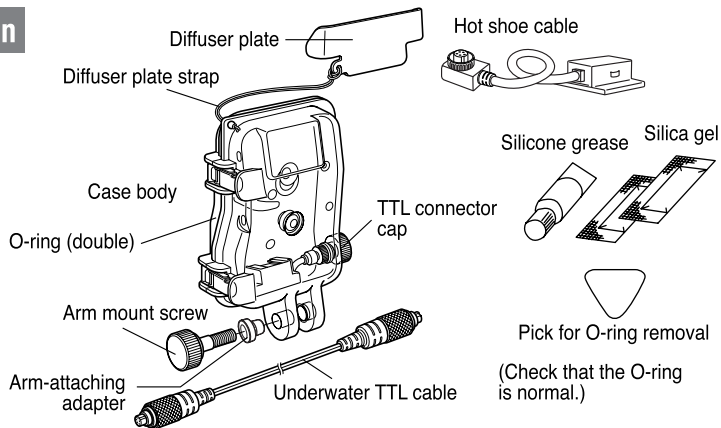

Instruction manual  
(this manual)



Warranty card

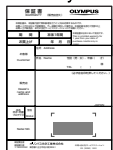

Diver's insurance guide



Please read before use



E-9

## Names of the parts

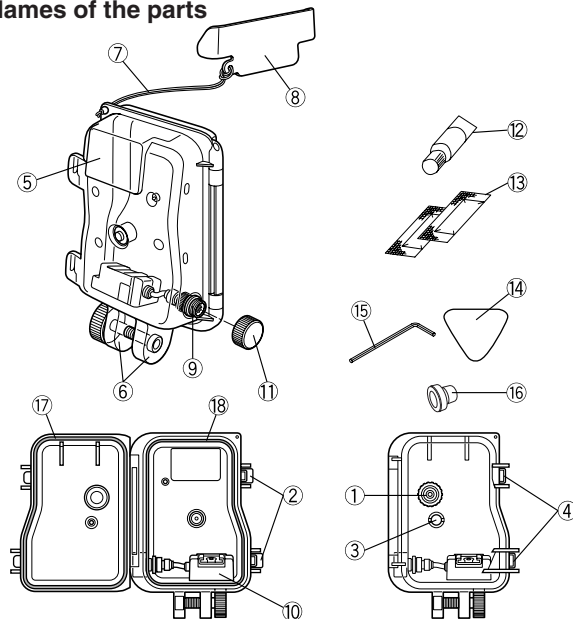

- \*① Mode dial
- ② Buckle hook
- \*③ Test button
- ④ Buckle open/close lever
- ⑤ Light-emitting window
- ⑥ Arm mount
- ⑦ Diffuser plate strap
- ⑧ Diffuser plate
- ⑨ Underwater TTL cable connector
- ⑩ Hot shoe
- ⑪ Underwater TTL cable connector cap
- ⑫ Grease for silicone O-ring (white cap)
- ⑬ Silica gel
- ⑭ O-ring removal pick
- ⑮ Buckle opener
- ⑯ Arm attaching adapter
- ⑰ O-ring (POL-201A)
- ⑱ O-ring (POL-201B)

Note : The case parts marked with an asterisk (\*) correspond to functions on the electronic flash. Consequently, operation of these parts activates the corresponding functions in the flash. For details on these functions, refer to the electronic flash's instruction manual.

E-10

## Preparing the case

Before shooting, prepare the case as described below.

## Attaching/removing/ the diffuser plate

This case is equipped with a diffuser plate that can be used to attenuate the flash light.

Use the diffuser plate to weaken the shadow of the subject as well as to attenuate the light.

The diffuser plate can be attached or removed as shown below.

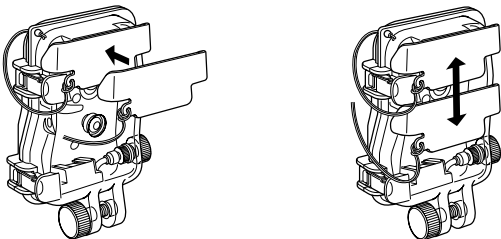

**CAUTION** : When not using the diffuser plate, place it on the center part on the front of the case as shown on the right.

## Connection to the camera case

To perform underwater TTL shooting using this case, connect the underwater TTL cable between this case and the camera case. Connect the hot shoe cable (provided with this case) between the TTL cable connector in the camera case and the camera's hot shoe.

### 1)Connecting the underwater TTL cable

Make sure that both case's are dry, and loosen and remove the TTL cable connector cap from each case.

After removing the cap, connect either end of the underwater TTL cable connector to the uncapped TTL cable connector in the case. Pay attention to the following points ; ① check the orientation of the 5 pins in the TTL cable's connector and align it so that the pins fit into the corresponding receptacles in the case's TTL connectors ② turn the lock dial screw on the TTL cable's connector all the way clockwise to lock the connector firmly.

The underwater TTL cable can be disconnected from each case by reversing the above connection steps. In the final step, screw the cap back onto the case's TTL cable connector until it is stops.

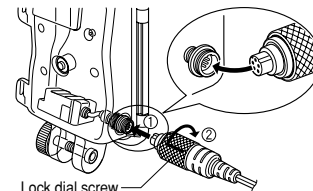

**CAUTION** :

- Always make sure that the case are completely dry before connecting or disconnecting the underwater TTL cable.
- O-rings are attached to the case's TTL connector caps and the underwater TTL cable's connectors to keep out water. If any fibers, sand or hair are attached to an O-ring, the integrity of the waterproof function will be affected and water penetration may result. Be sure to check and remove any foreign matter on the O-rings before connecting these connectors.
- Pay attention to the position of the 5 pins when connecting the connectors.
- Do not use excessive force when tightening the lock dial screw on the cable's connector.
- When the underwater TTL cable is not connected, be sure to put the caps back on the TTL cable connectors.

## 2) Connecting the hot shoe cable

Connect the hot shoe cable, provided with this case, between the TTL cable connector on the inner side of the camera case and the hot shoe of the camera. Pay attention to the following points: ① before inserting the camera into the camera case, loosen and remove the cap on the TTL cable connector inside the camera case; ② insert the 5-pin connector of the hot shoe cable into the TTL cable connector inside the camera case; ③ turn the lock dial screw on the hot shoe cable's connector all the way clockwise to lock the connector firmly; ④ insert the camera into the camera case; ⑤ after inserting the camera, insert the hot shoe unit of the hot shoe cable all the way into the camera's hot shoe.

The hot shoe cable can be disconnected by reversing the connection steps. In the final step, screw the cap back onto the TTL cable connector inside the camera case until it stops.

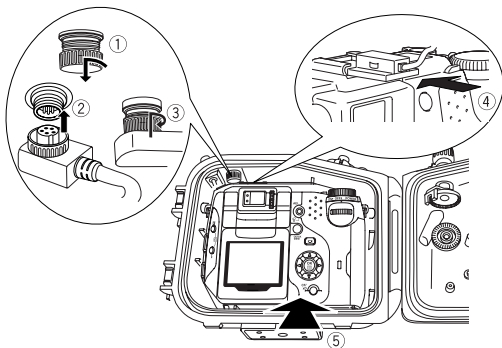

**⚠ CAUTION :**

- Pay attention to the position of the 5 pins when connecting the connectors.
- Do not use excessive force when tightening the lock dial screw on the cable's connector.
- When the hot shoe cable is not connected, be sure to put the caps back on the TTL cable connectors.

## 3) Mounting on an arm

This case can be mounted on a commercially available arm or similar tool as described below.

When using a commercially available arm with a width of 12 mm, mount the provided arm-attaching adapter in the direction shown in ① below. When using an arm with a width of 10 mm, mount adapter in the direction shown in ② below.

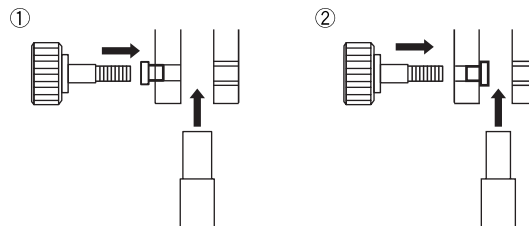

Insert the commercially purchased arm into the arm mount, and then tighten the arm by inserting and turning the provided arm mount screw all the way clockwise.

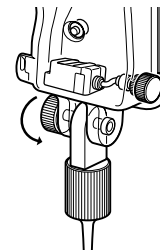

**⚠ CAUTION :**

- The arm mount of this case has an interval of 12 mm. Use care when mounting it on a commercially purchased arm.
- Do not tighten the arm mount screw with excessive force.



## 2. Advance Check of the Case

### Advance test before use

This Case has been the subject of thorough quality control for the parts during the manufacturing process and thorough function inspections during the assembly. In addition, a water pressure test is performed with a water pressure tester for all products to confirm that the performance conforms to the specifications. However, depending on the carrying and storage conditions, the maintenance status, etc., the waterproof function may be damaged.

Before diving, always perform the following advance test and the water leakage test after installation of the flash.

### Advance Test

1. Before inserting the electronic flash, take the empty case to the intended depth and make sure that no water gets inside the case.
2. Main causes of water leakage are as follows.
  - The O-ring has not been installed.
  - A part of the O-ring or the entire O-ring is outside the specified groove.
  - O-ring damage, cracks, deterioration or deformation
  - Sand, fibers, hair or other foreign matter sticking to the O-ring, the O-ring groove or the O-ring contact surface.
  - Damage to the O-ring groove or the O-ring contact surface.
  - When closing the Case, check for catching of the hand strap and silica gel after the above causes have been eliminated.

**△CAUTION :** • The most suitable method for checking water leakage is to immerse the Case to the intended water depth. When this is difficult, water leakage also can be checked at a shallow depth with no water pressure. Do not feel that this is troublesome, but perform this test.  
• If the advance test should show water leakage with normal handling, stop using the Case and contact your dealer or an Olympus service station (listed on the rear page of this instruction manual).

## 3. Inserting the electronic flash.

### Checking the electronic flash

Load batteries into the electronic flash and perform the flash check before inserting the flash in the case.

### Checking the batteries

Load two LR6 alkaline batteries, two lithium batteries, two Ni-Mn batteries, two Ni-Mh batteries or two Ni-Cd batteries as shown below.

Manganese batteries cannot be used.

- ① Set the mode dial to AUTO.
- ② When the charge lamp lights up, press the test button and ensure that the flash emits light.

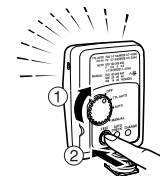
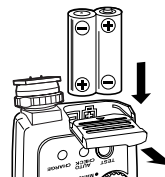

**Note:** • To avoid running out power during shooting, it is recommended to load fully charged batteries before every diving session.

### Inserting into the case

### Which electronic flashes can be used?

The product (PFL-01) is exclusively for use with the FL-20 Electronic Flash.

## Open the Case.

Insert the buckle opener of the accessory into the buckle opening lever as shown in the figure (in direction ①) Pull the buckle opener slowly (in direction ②). When not using the buckle opener, hold the buckle opening lever with your thumb and index finger from the side and pull it up slowly.

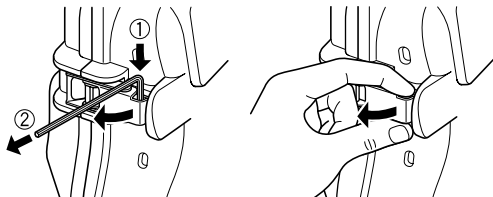

## Inserting the flash

Carefully insert the FL-20 Electronic Flash into the hot shoe of this case. Make sure that the protruding part of the camera's zoom lever fits properly in the notch in case's zoom lever. Follow the steps shown in the illustration; ①insert the flash all the way into the hot shoe; ②turn and tighten the shoe lock dial of the flash.

To remove the FL-20 from this case, follow these steps; ③ turn and loosen the shoe lock dial of the flash; ④ holding the flash's dial firmly with a finger, slide the case out of the flash's hot shoe.

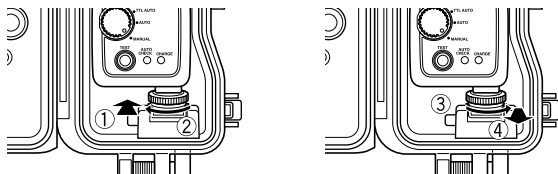

- ⚠ CAUTION :**
- Be sure to turn the flash off before inserting it into this case.
  - Do not apply excessive force to the flash when inserting it.
  - When removing the flash from this case, hold the flash so as not to drop it.

## Insertion of silica gel

Before closing the case, place the provided bag of silica gel (to prevent fogging) between the right side panel of the flash and the case. Insert the bag with the longer, glued side first.

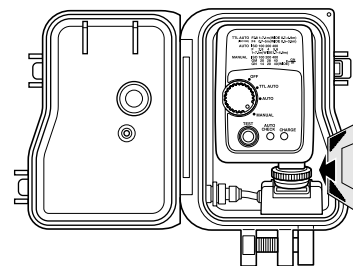

- ⚠ CAUTION :**
- Insert the silica gel all the way at the specified location and with the specified orientation. When the orientation is not correct, the silica gel bag will be caught when the Case is sealed and water leakage will be caused.
  - Attempting to seal the Case with the bag inserted only part of the way will cause the silica gel bag to get caught by the O-ring and water leakage will occur.
  - Once silica gel has been used, the moisture absorption performance will be impaired. Always exchange the silica gel when the Case is opened and closed.



## Check the loading status.

Always perform the following final checks before sealing the Case.

- Has the electronic flash been inserted properly into the hot shoe of the case?
- Has the silica gel been inserted all the way at the specified position?
- Has the O-ring at the Case opening part been installed properly?
- Are the O-ring and the O-ring contact surface on the front lid free of dirt and other foreign matter?

## Seal the Case.

When the rear lid is closed (quietly, so that the O-ring will not come out of the groove), the buckles are engaged with the edge of the rear lid, and the buckle lock levers are pushed down in arrow direction, the Case will be sealed airtight.

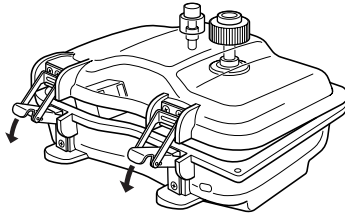

**CAUTION :** • Seal the Case by turning both buckle lock levers down in arrow direction. When one of the buckles is left open, the Case will not be sealed and water leakage will be caused.



## Perform the final checks.

### Visual Inspection

After sealing the Case, check the sealing part of front and rear lid visually to confirm that the O-ring is not twisted or out of the groove and that no foreign matter has been caught.

**CAUTION :** • Hairs, fibers, and other narrow items are not very apparent, but they may cause entry of water, so that special attention is required.

### Setting the flash power to ON and OFF

Turn the mode dial knob and confirm that the electronic flash can be turned ON and OFF.









Also turn the mode dial knob and confirm that the flash's mode dial can be switched to TTL AUTO and MANUAL.

**CAUTION :** • After inserting the flash into the case, confirm that the mode dial moves. If it does not move, oil or grease may have gotten on the mode dial. Wipe it clean.

## Final Test

After the electronic flash has been inserted in the case, you should perform the final system check. This covers all tests that you must carry out to make sure that no water can enter the case. The tests are easy to do and only take about 5 minutes. All you need is a bowl or tub of water.

\*The following procedure was originally developed to test for water penetration inside the camera case. The test procedure for the waterproof flash case is identical, so please follow these steps.

	Simple water immersion test	Explanatory image	Hints
1	Place the Case slowly into the water.		As the Case is transparent, waterdrops entering into it can be confirmed easily.
2	At first, immerse the Case for only three seconds.		In case of trouble with the O-ring, three seconds are enough for water to enter. Are there air bubbles coming out between the lids? Please check carefully.
3	Check that no water has entered into the Case.		Remove the Case from the water and check that no water has accumulated at the bottom of the Case. Is there any water trickling down?
4	Next, immerse the Case for 30 seconds.		Check carefully for air bubbles! Do not perform any operation yet, but just observe.
5	Check that no water has entered.		Remove the Case from the water and check that no water has accumulated at the bottom of the Case. Perform very careful confirmation.
6	Next, check by immersing for three minutes.		Check carefully for air bubbles! Try operation of the buttons used frequently. Check carefully for air bubbles! If there is still no entry of water, everything is OK!
7	This is the final check. Has the silica gel become moist?		This is very important! Has the silica gel become moist? Please check carefully! As the inside can be seen, the inspection for entry of water also can be made securely!
8	Now everything is all right.		Now everything is all right! Have a nice dive!

## 4. Taking photos underwater

### Setting the flash mode

This case enables underwater TTL AUTO shooting.

**CAUTION :** • When this case is used, the AUTO mode of the electronic flash cannot be used. Even if the mode dial of the flash is set to AUTO, it emits light at the maximum intensity.

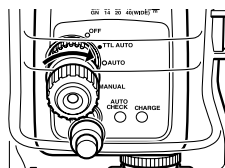

### Underwater TTL AUTO shooting

Turn the case's mode dial knob to set the electronic flash to the TTL AUTO mode. For details including the digital camera setup, refer to the camera and flash instruction manuals.

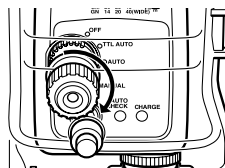

### Underwater MANUAL shooting

Turn the case's mode dial knob to set the electronic flash to the MANUAL mode. For details including digital camera setup, refer to the camera and flash instruction manuals.

**CAUTION :** • For the camera's iris setting and standard shooting range, refer to the flash instruction manual.  
• The underwater flash shooting range (distance) maybe reduced depending on the conditions at the time of shooting (clarity of the water, suspended matter, etc.). Be sure to check the image on the camera's LCD monitor before actual shooting.

## 5. Handling After Shooting

### Wipe off any waterdrop.

After underwater shooting, remove any drops of water from the case. Use pressurized air or a soft, lint-free cloth to carefully wipe away any moisture from the hinge between the front and rear lids, the TTL cable connector and the buckles.

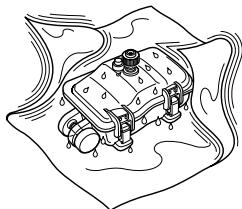

- ⚠ CAUTION:**
- Especially when waterdrops remain between the front and the rear lid, they may spill to the inside when the Case is opened. Take special care to wipe off all waterdrops.
  - When opening the Case, take sufficient care that no water will drop from your hair or body onto the Case and the flash.
  - Before opening the Case, make sure that your hands or gloves are free of sand, fibers, etc.
  - Do not open or close the Case at locations where water or sand is to be sprayed. When this cannot be avoided because you have to exchange the battery, place a sheet downwind from some object and take care that no water or sand is sprayed.
  - Never touch the electronic flash and/or batteries when your hands are wet with sea water.

**Note:** Moisten a towel etc. in advance with pure water and keep it in a plastic bag so that you can wipe the salt from your hands and fingers before handling the camera.

## Removing the electronic flash

Carefully open the case, loosen the shoe lock dial of the flash and, while holding the mode dial knob on the case firmly, slide the flash out of the case's hot shoe.

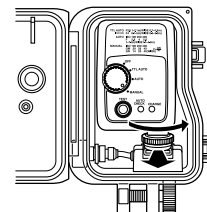

- ⚠ CAUTION :**
- After opening the case, always put it down with the O-ring side face-up. Otherwise, dirt or other foreign matter could attach itself to the O-rings and/or the contact surfaces, allowing water to penetrate the case during the next dive.
  - Before removing the flash, make sure the flash's shoe lock dial is loose. Never use force to remove the flash. This could damage the flash or the case.

## Cleaning the case with pure water

After using this case, remove the flash, then seal it again with the TTL cable still connected, and rinse it with pure water as soon as possible. After use in salt water, the case should be immersed for an extended period of time in a bowl of pure water to remove any salt water or salt residues.

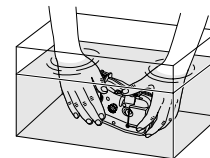

- ⚠ CAUTION :**
- Water may enter the case under localized high water pressure (such as from a hose.) Before cleaning the case with water, the flash should be removed.
  - Operate the mode dial knob and buttons of the case when it is in clean tap water to remove any salt from their shafts. Do not disassemble the case for cleaning!
  - If the case is dried before all salt has been removed, this could affect its performance. Always make sure all salt has been removed!
  - If the case should be cleaned without the TTL cable connected to it, be sure to attach the cap to the connector in advance.



## Disconnecting the TTL cable

After making sure that the case and TTL cable are free of water drops, loosen the lock dial screw and disconnect the TTL cable.

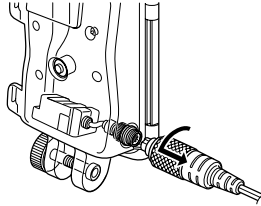

En

- CAUTION** :
- Do not apply excessive force when disconnecting the TTL cable.
  - Make sure that no foreign matter such as dirt is attached to the O-ring of the connector. Should any foreign matter be attached to it, wipe it clean with a clean, lint-free cloth.
  - Be sure to attach the cap to the TTL cable connector after disconnecting the cable.

## Drying the case and TTL cable

After washing the case and TTL cable, dry them with a clean, soft, lint-free cloth. Then, leave them to dry completely in a well-ventilated location protected from direct sunlight.

- CAUTION** :
- Never use hot air from a hair dryer or other appliance to dry the case and TTL cable, and never place them in direct sunlight to dry. This could deteriorate or deform the case, TTL cable and O-ring and lead to water penetration. When wiping the case, take care not to scratch it.

## 6. Maintaining the Waterproof Function

### Remove the O-ring.

Open the Case and remove the O-ring from the Case.

Removal of the O-ring

- ① Insert the O-ring removal pick between the O-ring and the wall of the O-ring groove.
- ② Move the tip of the inserted pick under the O-ring. (Take care not to damage the O-ring groove with the tip of the pick.)
- ③ Hold the O-ring with your fingertips after it has come out of the groove and remove it from the Case.

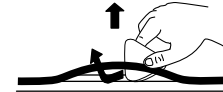

En

### Remove any sand, dirt, etc.

After visually checking that dirt has been removed from the O-ring, checking for attached sand and other foreign matter, as well as for damage and cracks can be done by squeezing the entire circumference of the O-ring lightly with your fingertips.

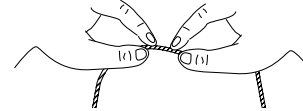

Using a clean cloth free of fibers, etc., a piece of lint-free tissue paper or a soft toothbrush, remove any foreign matter attached to the grooves of the O-rings. Also remove sand and dirt particles attached to the O-ring contact surfaces on the case.

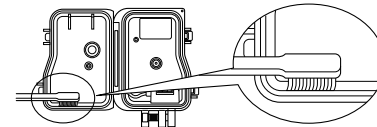





- ⚠CAUTION:**
- When a mechanical pencil or a similar other sharp object is used to remove the O-ring or to clean the inside of the O-ring groove, the Case and the O-ring may be damaged and water leakage may be caused.
  - When the O-ring is checked with the fingertips, take care not to stretch the O-ring.
  - Never use alcohol, thinner, benzene or similar solvents or chemicals detergents to clean the O-ring. When such chemicals are used, it is likely that the O-ring will be damaged or that its deterioration will be accelerated.

## Install the O-ring

Confirm that no foreign matter is attached, apply a thin coat of the accessory grease to the O-ring, and fit the O-ring into the groove. At this time, confirm that the O-ring does not stick out from the groove.

\*This sections explains how to apply lubricant to the camera case. Use the same procedure for the flash case.

## How to Apply Grease to the O-ring

1	Apply the specified grease		Make sure there is no dirt on your fingers or on the O-ring; then squeeze about 5 mm of grease onto your fingertip.
2	Spread the grease over the O-ring.		Using two fingers and a thumb, spread the grease over the O-ring while rubbing it in. Use caution not to squeeze or pull the O-ring too hard.
3	Check that there is no damage or irregularities on the O-ring.		Once the grease has permeated throughout the O-ring, check it for damage or irregularities (both visually and by touch). If you notice any abnormalities, replace the O-ring with a new one.
4	Apply the grease to the O-ring contact surface.		Use any residual grease on your fingertips to clean and lubricate the O-ring contact surface on the front lid.

- ⚠CAUTION:**
- Always perform maintenance of the waterproof function even when the Case has been opened to exchange the battery or the image storage during shooting. Neglecting this maintenance may become the cause of water leakage.
  - When the Case is not to be used for a long time, remove the O-ring from the groove to prevent deformation of the O-ring, apply a thin coat of silicone grease, and store it in a clean plastic bag or the like.
  - When drying is done with salt attached, it is likely that a function impairment will be caused. After use, always wash off any salt.

## Replace consumable products.

- The O-ring is a consumable product. Independent of the number of times the Case is used, it is recommended that the O-ring should be replaced by a new one at least once a year.
- Deterioration of the O-ring is accelerated by the use conditions and the storage conditions. Replace the O-ring even before a year has passed if it shows signs of damage, cracking or loss of elasticity.

**Note:** • Please use original Olympus products for the silicone O-ring grease, the silica gel, and the O-ring. These consumable products also can be purchased at an Olympus service station.

## 7. Appendix

### Q & A on the use of the PFL-01

Q1 : Which electronic flashes can be used with this case?

A1 : The PFL-01 case is designed exclusively for the FL-20 Electronic Flash.

Q2 : What points should be observed when inserting the electronic flash into the case?

A2 : When inserting the flash you should pay special attention to the following points:

- (1) Check that the flash's batteries are fully charged.  
Insert the flash into the case's hot shoe properly and tighten the flash's shoe lock dial.
- (2) Before closing the case, check that the O-rings are correctly attached to the case.
- (3) Make sure that the O-rings and contact surfaces are free of foreign matter such as hair and dirt.
- (4) Place the bag of silica gel in the case to avoid fogging. Only use Olympus silica gel.
- (5) Make sure that the TTL cable and hot shoe cable are connected firmly.

Q3 : What cautions must be observed when using and storing the Case?

A3 : Pay special attention to the following items.

- (1) When the O-ring contact surface is pressed strongly from the outside of the Case, or when the Case is twisted, the waterproof function may be impaired and water leakage may be caused.
- (2) When the Case is used, left or stored at the following locations, defective operation or trouble may be caused. Always avoid such locations.
  - (a) Places where the Case can reach high temperatures under direct sunlight or in a car, places with extremely low temperatures, and places with extreme temperature variations.
  - (b) Places with open fire
  - (c) Places with volatile substances
  - (d) Places with vibrations
- (3) The following instances could lead to operational problems and/or damage to this case and the flash inserted in it. Avoid knocks and sudden increase in pressure caused by:
  - (a) Hitting other objects
  - (b) Dropping
  - (c) Placing heavy objects on top of the Case
- (4) When the Case is not used for a long time, trouble from formation of mold etc. may be caused. Before use, confirm the operation of all

operation parts and perform the advance test and the final test.

(5) When not using this case, be sure to take the flash out.

Q4 : What cautions must be observed when opening and closing the Case?

A4 : Pay special attention to the following items.

- (1) Do not open and close the Case at locations with water spray or sand spray.
- (2) Wipe off all waterdrops from the gap between the front lid and the rear lid and around projections and recesses such as the buckles. When this is not done, entry of waterdrops into the Case is to be feared at the time of opening and closing.
- (3) When opening the case, make sure no water from outside (e.g. dripping from your hair or diving suit) gets inside the case and/or on the flash!
- (4) When the Case is open, check that there is no attachment of sand, fibers or other foreign matter to the O-ring and the O-ring contact surface.
- (5) Never touch the flash with a hand wet with sea water.
- (6) If you notice while diving that water has entered the case, stop the dive immediately and perform water leak test to check for water penetration. If any water has reached the electronic flash, do not use it, dry it immediately and contact your dealer or Olympus.

Q5 : How to handle the case after use?

A5 : After using the case, remove the flash and rinse the case off in pure water as soon as possible. After use in salt water, you should immerse the case for an extended period of time in pure water. Operate the mode dial knob and buttons of the case when it is in clean tap water to remove any salt from their shafts. After rinsing, remove moisture with a dry cloth free of salt, and dry the case in the shade. Never use hot air from a hair dryer or other appliances to dry the case, and never place it in direct sunlight to dry, as this could deform, discolor, damage or deteriorate the case and O-rings. The inner side of the case should be wiped with a soft, lint-free cloth. Remove the O-rings, wipe off the attached foreign matter such as salt, sand and dirt, also clean the grooves in which O-rings have been fit and the surfaces in contact with O-rings, and dry all of them. When removing an O-ring from the groove, do not use a sharp object to avoid damaging the O-ring and causing leaks. Be always sure to use the provided pick for removing the O-ring.

Q6 : What points should be considered when using the case underwater?

A6 : Please remember the following points.

- (1) Mount the case properly on a commercially available bracket or arm.
- (2) Adjust the case orientation so that the flash light is not obstructed.
- (3) Set the flash mode to TTL AUTO or MANUAL. (For the camera setup in



these modes, refer to the instruction manual for the camera or flash.)

Q7: How can I check for water leakage?

A7: Here you should carry out the first check and the final system check with the flash inside the case.

It is also recommended that you carry out the first check by diving to the intended depth with the empty case. If this is not possible, this test should be carried out at a depth of at least one meter or in a container of water (e.g. a bath, bucket, etc.). The final system check can then be carried out in a similar container of water.

Q8: What are the causes for entry of water?

A8: The main causes for the entry of water are shown below. Please check them most carefully.

- (1) Forgetting to install the O-ring
- (2) The O-ring is partly or completely outside the groove.
- (3) Damage, deterioration, or deformation of the O-ring
- (4) Sand, fibers, hair or other foreign matter on the O-ring
- (5) Sand, fibers, hair or other foreign matter on the O-ring groove or the O-ring contact surface
- (6) When the bag of silica gel is caught between the front and rear lids when closing the case.
- (7) Throwing the Case from a boat into the water, jumping with the Case into the water, or other sudden application of strong forces onto the Case. When entering the water, hand the Case over quietly or avoid impacts in other ways.

Q9: What are the important points for O-ring maintenance?

A9: Please observe the following items.

- (1) Never use alcohol, thinner, benzene or similar organic solvents or chemical detergents to clean the O-ring. When such chemicals are used, it is to be feared that the O-ring will be damaged or that its deterioration will be accelerated.
- (2) Use the original Olympus silicone O-ring grease (white cap). The grease attached to Cases up to PT-008 (red cap) and the grease of other companies are not suitable for this silicone O-ring, and use of such grease may cause deterioration of the surface and impairment of the waterproof function.
- (3) In order to avoid deformation of the O-ring when the Case is not used for a long time, remove the O-ring from the Case, apply a thin coat of the special grease, and store the O-ring in a clean plastic bag. For reuse, confirm that the O-ring is free of damage and cracks, that it has sufficient elasticity, that the surface is free of stickiness and other abnormalities,

and use it after applying a thin coat of the special grease. Excessive application of grease does not improve the waterproof function or the permissible withstand pressure. However, it may facilitate attachment of sand, dirt, etc.

A thin, uniform coat produces the best result.

- (4) The O-ring is a consumable product. Replace it at least once a year.
- (5) Deterioration of the O-ring is accelerated by the use conditions and the storage conditions. Replace the O-ring immediately by a new one if it shows signs of damage, cracking or loss of elasticity.

Q10: What are the important points for Case maintenance?

A10: Please observe the following items.

- (1) Never use the following chemicals for cleaning, corrosion protection, defogging, repair or other purposes.
  - Never use alcohol, thinner, benzene or similar volatile organic solvents or chemical detergents to clean the Case. Pure water or lukewarm water is sufficient for cleaning.
  - Do not use anticorrosion agents on the metal parts. The metal parts are made of aluminum, brass or stainless steel. Cleaning with pure water is sufficient.
  - Do not use commercial defogging agents. Always use the original Olympus defogging silica gel.
  - Do not use adhesive for repairs or other purposes. When repair is required, please contact a service station of our company or your dealer.

Q11: Please tell me about repairs.

A11: Please contact a service station of our company or your dealer, if repair should be necessary. Do not try to repair, disassemble or modify the Case yourself. Repair, disassembly or modification by you or third parties not authorized by Olympus invalidates the guarantee.

Q12: What are the model numbers of the PFL-01 accessories?

A12: The following accessories are being sold.

- (1) O-ring for the PFL-01 body (POL-201A/ ¥ 1,000, POL-201B/ ¥ 1,000): This is a silicone rubber O-ring packing to be installed in the PT-019 body to make it waterproof. O-rings for other Case models cannot be used.
- (2) Silicone O-ring grease (PSOLG-1/ ¥ 800): This is a special grease for silicone O-ring maintenance.
- (3) Silica gel (SILCA-5/ ¥ 500): This is a desiccant used to prevent fogging of the glass parts of the Case. The quantity is five bags.  
\*You can order in large computer shops and camera mass sale stores.

\*Please contact your dealer or a service station of our company when replacement is required. Replacement will be made against payment.

Q13: How can I take good underwater photos?

A13: The web page of the visual college of the Club Camedia has a corner for underwater shooting techniques. Please take a look.

URL : <http://www.olympus-zuiko.com/school/index.html>

## After-sale Service

- You will receive the Warranty card from your dealer. Please make sure that the dealer's name, the date of purchase, etc. have been entered. If they have not been entered, immediately ask your dealer to have them entered. Read the guarantee conditions carefully and keep the guarantee card at a safe location.
- Please contact your dealer or one of the service stations of OLYMPUS CORPORATION listed in this instruction manual for questions on aftersale service for this product or in case of defects. In case of a defect of this product, occurring within one year after the date of purchase and with handling according to this instruction manual, repair based on the conditions specified in the guarantee card is performed free of charge.  
Payment is required for repairs after expiration of the guarantee period and for trouble caused by problematic handling by the customer even during the guarantee period.
- OLYMPUS CORPORATION keeps repair parts for this product for approximately five years after the end of production of the product. Accordingly, in principle repairs are accepted during this period. As repair may be possible even after this period, please contact your dealer or a service station in your neighborhood.
- Warranty is limited to and valid only in the region of intended distribution.
- Incidental damages from defects of this product (expenses required for diving, shooting expenses, loss of profit from photos, etc.) shall be excluded from the guarantee. In addition, transport expenses etc. related to repair shall be paid by the customer, independent of whether they are incurred during or after the guarantee period.

## Specifications

Available models	Olympus digital camera and Electronic Flash (FL-20)
Pressure resistance	Depth of up to 40 m
Main materials	Main body : Transparent polycarbonate Buckle : Stainless steel Buttons, arm mount screw, adapter : Nickel-plated brass Diffuser plate : Acrylic resin
Dimensions	Width 111.5 mm x height 154.2 mm x thickness 76.2 mm (excluding the diffuser plate)
Weight	325 g (without flash and accessories)

\* We reserve the right to change the external appearance and the specifications without notice.

### Diver's Insurance Guide

We recommend to subscribe to diver's insurance for water leakage. For details, refer to the enclosed Diver's Insurance Guide.

MEMO

En

En